

FLEXA®

82-50001-1/-2

65/75 x 122 x 90cm

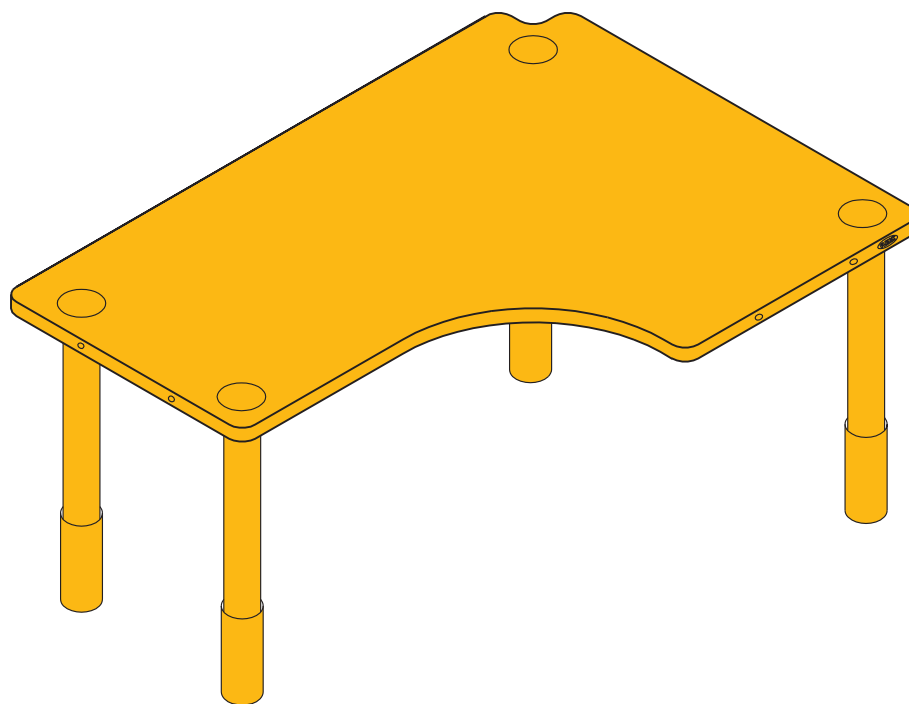

Monterings- og brugsvejledning
Assembly instructions and direction for use
Montageanleitung und Gebrauchsanweisung
Notice de montage et mode d'emploi
Montageinstructie en onderhouds voorschrift
Instrucciones de montaje y uso
Istruzioni di montaggio e uso
Kokoamis- ja käyttöohjeet
Οδηγίες συναρμολόγησης και χρήσης

Instrukcje montażu i wskazówki dotyczące użytkowania
Instruções de montagem e de utilização
Instrucțiuni de asamblare și recomandări de utilizare.
Инструкции по сборке и руководство использования
安装及使用说明
組立ておよび使用説明
รายละเอียดเกี่ยวกับวิธีการใช้
และการติดตั้ง
설치 및 취급설명

For indoor
domestic use

Scandinavian Design made in Estonia



Møbler fra FLEXA er fremstillet af enten massivt træ eller højvaldet MDF. Massivt træ kan have åre- og strukturskille, hvilket er en naturlig del af møblet, fordi det er et naturmateriale.

Skulle der mod forventning opstå en reklamation, skal denne blanket udfyldes og returneres til FLEXA forhandleren. Venligst kontroller, at alle dele er komplette, inden



Furniture from FLEXA is produced from solid wood or high quality MDF. Solid wood can have color and structure differences, which is a natural part of the furniture.

However should a complaint occur, this form must be filled and returned to your FLEXA Stockist. Please ensure all parts are complete before you start assembling.



Die FLEXA Produkte werden aus massivem Holz oder aus hochwertigem MDF von hoher Qualität hergestellt.

Bei massivem Holz sind Farbunterschiede sowie unterschiedliche Maserungen Naturmerkmale. Sollte es trotzdem Grund zur Reklamation geben, füllen Sie bitte diesen Schein aus und wenden Sie sich an Ihren FLEXA Händler. Kontrollieren Sie vor Montagebeginn den Artikel auf Vollständigkeit und Beschädigungen.



Le mobilier FLEXA est réalisé en bois massif ou en MDF de haute qualité. La structure et la couleur peuvent varier naturellement.

Si toutefois vous constatez une anomalie, merci de remplir la fiche ci-jointe et de la retourner à votre revendeur. Veuillez vérifier l'intégralité des pièces avant d'entreprendre le montage.



Los muebles de FLEXA son fabricados con madera maciza o MDF de alta calidad.

La madera maciza puede tener diferencias de color o textura naturales, esto es una parte natural de los muebles.

Si en contra de lo previsto surge una incidencia, hay que rellenar este formulario y devolverlo al distribuidor. Los rogamos controlar que todas las piezas estén completas antes de empezar el montaje.



Mebelen van FLEXA zijn gemaakt van hoogwaardig hout of hoge kwaliteit MDF.

Bij massief hout kunnen kleur- en structuurverschillen voortkomen, wat een natuurlijk kenmerk is van het meubilair.

Wocht er desondanks een klacht ontstaan, vul dan dit formulier in en lever het in bij uw FLEXA dealer. Controleer of alle benodigde onderdelen aanwezig zijn voordat u begint met monteren.



I mobili FLEXA sono prodotti in legno massiccio o MDF di alta qualità.

Il legno massiccio può avere alcune differenze di colore o di consistenza, il che è normale per un materiale naturale.

Comunque per qualsiasi reclamo bisogna riempire il modulo e consegnarlo al Vostro rivenditore. Vi preghiamo di controllare che tutti i pezzi siano intatti prima di cominciare il montaggio.

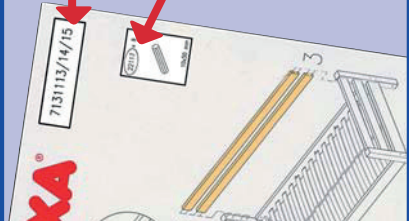

Model nr. / Model No / Modell Nr. /
Modèle no / No Modelo / Artikel nr. /
Numero Modello

Emne nr. / Part / Teile-Nr. /
Pièce réclamée / No. pieza /
Onderdeelnummer / No. pezzo

Årsag

Manglende del / Missing part /
Fehlendes Teil / Pièce manquante /
Falta pieza / Missende delen / Parte
mancante

Reason

Ursache

Fejl i træet / Defect in the wood /
Holzfehler / Défaut de bois /
Madera defectuosa / Fout in het
hout / Difetto nel legno

Motif

Motivo

Fejlboring / Faulty drilling
Falsche Bohrung / Défaut de
perçage

Oorzaak

Taladro erróneo / Verkeerd geboord
Difetto forature

Motivo

4

Fejl i lakken / Fault in lacquer
Fehler im Lack / Défaut de finition
Barniz defecto / Fout in de
lakafwerking / Difetto laccatura



Møbler fra FLEXA er fremstillet af massivt træ, hvilket betyder at farve- og træstrukturforskelle er en naturlig del af møblerforskelte er reklamation, skal denne blanket udfyldes og returneres til FLEXA forhandleren. Venligst kontroller, at alle dele er komplette, inden montage påbegyndes.



Furniture from FLEXA is produced from solid wood, which means that colour and structure differences are a natural part of the furniture. However should a complaint occur, this form must be filled and returned to your authorized FLEXA dealer. Please ensure all parts are complete before you start assembling.



FLEXA家具由实木制成。存在实木的自然色和纹理的差异。若发现产品质量问题，请填写右侧的表格，送还给FLEXA授权经销商。安装前请按照包装清单仔细核对。



FLEXA家具由实木制成。存在实木的自然色和纹理的差异。若发现产品质量问题，请填写右侧的表格，送还给FLEXA授权经销商。安装前请按照包装清单仔细核对。



FLEXA家具は本製材として、木の自然の色と木目柄が異なります。製品に品質問題が发れれば、右の表をご記入の上、FLEXAの取扱代理店にご送付下さい。



FLEXA나무는 원목은 재료로 제작되어 원목 특유의 자연재질의 무늬가 나타납니다. 품질상의 문제가 발생하여 FLEXA의 공기 판매처에 보내주십시오. 심각한 품질리스크와 포장비용이 발생하면 하십시오.



FLEXAเฟอร์นิเจอร์เป็นผลิตภัณฑ์ที่ทำมาจากไม้จริงและมีความสวยงามทั้งนี้เนื่องจากไม้จริงมีความทนทานกว่าวัสดุสังเคราะห์ซึ่งมีความทนทานและสวยงามน้อยกว่าเฟอร์นิเจอร์ที่ทำมาจากพลาสติก



Model nr. / Model No / 产品编号 /
製品編號 / 製品ナンバー / 제품번호 /
หมายเลขสินค้า

Emne nr. / Part / 配件号 /
配件號 / パーツナンバー / 부품번호 /
หมายเลขชิ้นส่วนของอะไหล่

Årsag

Manglende del / Missing part /
配件缺失 / 配件缺失 / パーツ欠け /
配件缺失 / 부품 누락 / ชิ้นส่วนของอะไหล่ขาดหาย

Reason

原因

原因

原因は







이유

การณ

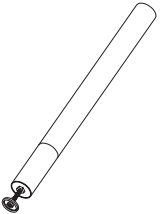
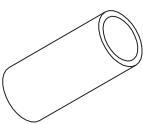
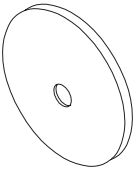
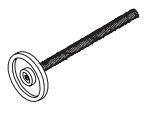
4

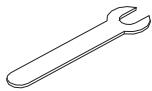
Fejl i lakken / Fault in lacquer /
油漆问题 / 油漆问题 /ペンキ問題 /
래키 문제 / 油漆不良 / 油漆不良 /
ตามตราฐาน



4081-001-2 x4 	4091-018-2 x4 	4092-007-2 x4  Ø75/Ø11x3mm
4005-003 x4  Ø48/M12	3927-00012 x4  M12	4033-001 x1  17/19mm
4092-006-2 x4  Ø50x10mm	4251-001 x1 	
82-50001-1 3939-000083-1 x4  8mm	82-50001-2 3939-000083-2 x4  8mm	

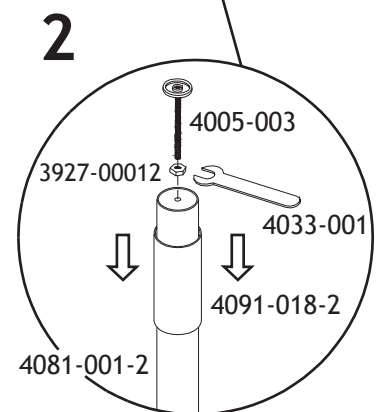
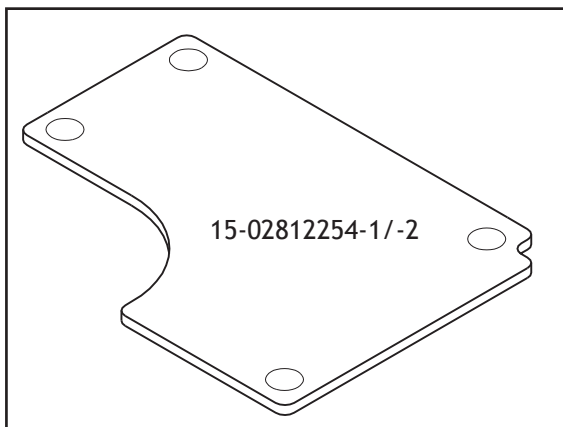
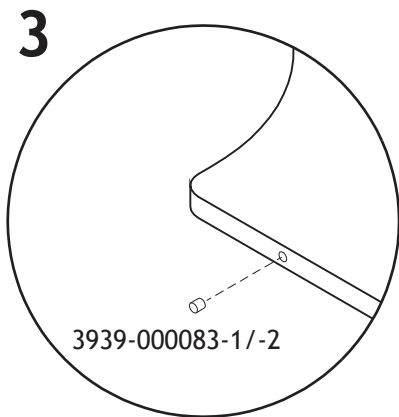
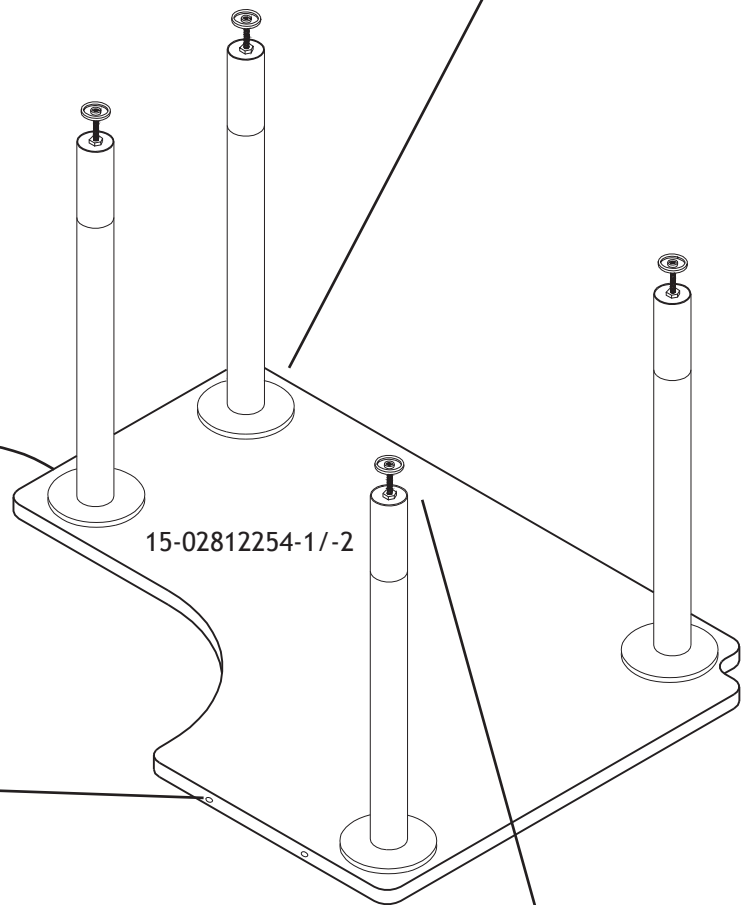
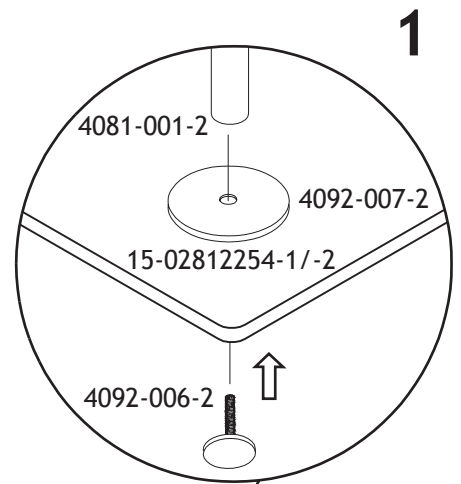

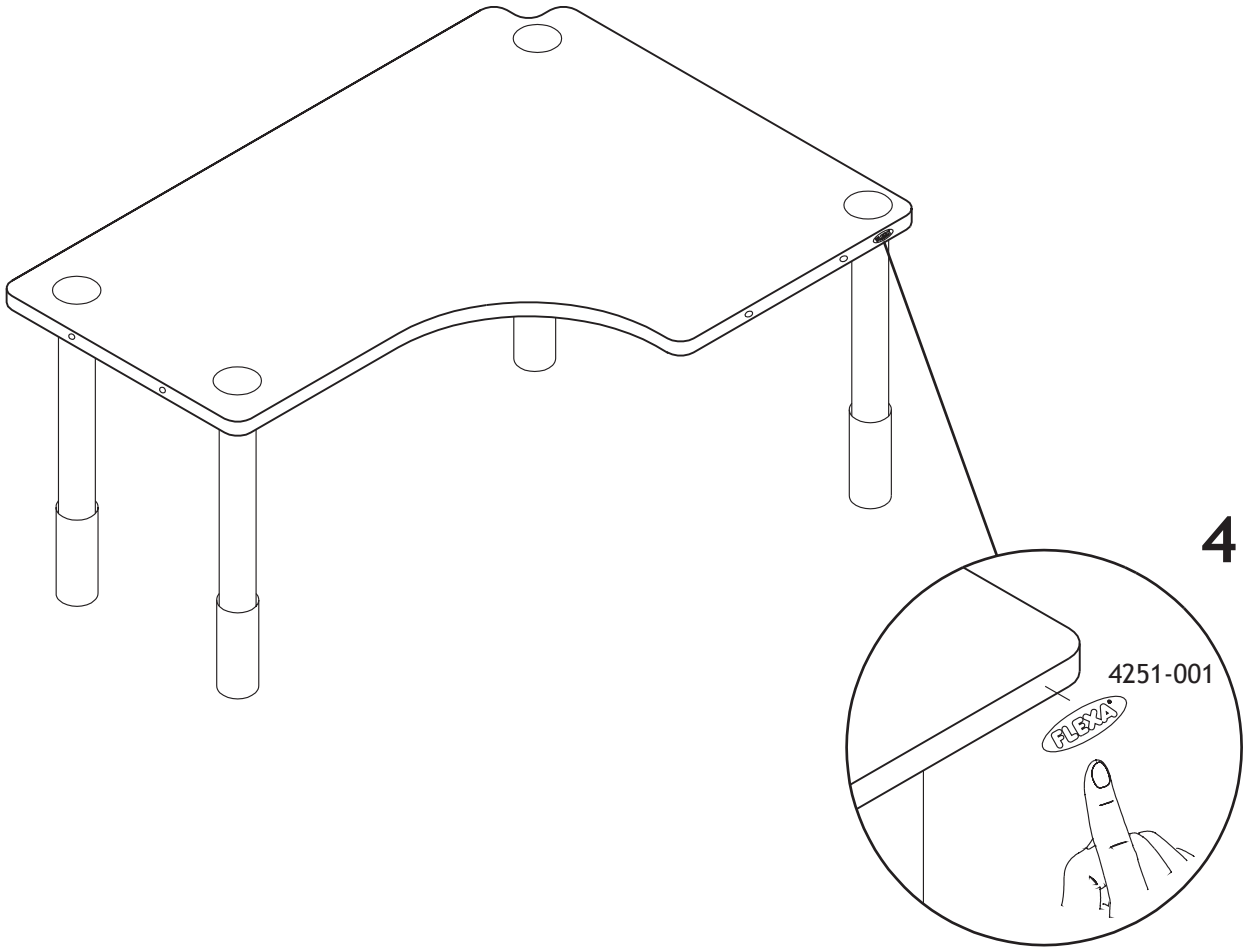

RÅD OM VELIGEHOJDELSE:

Tør af med en fugtig klud. Evt. større pletter fjernes større pletter fjernes med en fugtig svamp med sæbe. Undgå opløsningsmidler. Skruer og bolte efterspændes med jævne mellemrum.

MAINTENANCE INSTRUCTIONS:

Cleaning with a wet cloth, use a sponge with soap to remove obstinate dirt. Avoid solvents and dilutions. Screws and bolts should from time to time be retightened.

WARTUNGSANLEITUNG:

Mit einem feuchten Lappen säubern, nutzen Sie einen mit Seife getränkten Schwamm für hartnäckigere Verschmutzungen. Nutzen Sie keine Lösungsmittel oder Verdüner. Schrauben und Bolzen sollten gelegentlich neu festgezogen werden.

INSTRUCTIONS D'ENTRETIEN:

Nettoyage avec un tissu humide, utilisez une éponge avec du savon pour enlever la poussière obstinée. Évitez les solvants et les dilutions. Les vis et les boulons doivent être resserrés de temps en temps.

INSTRUCCIONES DE MANTENIMIENTO:

Limpieza con paño húmedo, use una esponja con jabón para remover la suciedad difícil de quitar. Evite solventes y diluciones. Los tornillos y pernos deben reajustarse ocasionalmente.

ONDERHOUDSINSTRUCTIES:

Schoonmaken met een vochtige doek, gebruik een spons met zeep voor het verwijderen van hardnekkig vuil. Vermijd oplossings- en verdunningsmiddelen. Schroeven en bouten regelmatig aandraaien.

LA MANUTENZIONE:

Pulire con un panno umido, usare una spugna con sapone per rimuovere lo sporco ostinato. Evitare solventi e diluizioni. Viti e bulloni devono di volta in volta essere riavvitati.

HOITO-OHJEET:

Puhdistetaan kostealla kankaalla, lian poistamiseen voidaan käyttää sientä ja saippuaa. Vältä liuotainaineita ja laimennoksia. Ruuvit ja pultit tulee kiristää säännöllisin väliajoin.

ΟΔΗΓΙΕΣ ΣΥΝΤΗΡΗΣΗΣ:

Καθαρίζετε το προϊόν με ένα υγρό πανί και χρησιμοποιήστε για να απομακρύνετε την επίμονη βρωμιά. Αποφύγετε διαλυμάτων. Οι βίδες και τα μπουλόνια θα πρέπει να

INSTRUKCJE KONSERWACJI: Czyścić przy pomocy wilgotnej Nie stosować rozpuszczalników i rozcieńczeń. Co jakiś

INSTRUÇÕES DE MANUTENÇÃO:

Limpe com um pano molhado. Use uma esponja com detergente para remover as manchas mais difíceis. Evite solventes e diluentes. Os parafusos e cavilhas deverão ser apertados de tempos a tempos.

INSTRUCȚIUNI DE ÎNTREȚINERE:

Se curățați cu un material textil umed, folosiți un burete cu să Evitați solvenții și diluanți. Șuruburile și buloanele trebuie refixate periodic.

ИНСТРУКЦИИ ПО УХОДУ:

Очищать влажной тканью, для удаления стойких загрязнений Избегайте использования растворителей и разбавителей от времени подтягивать.

维护说明：

用湿布清洁，用海绵沾肥皂清洁顽固污垢。避免使用溶剂和稀释液。应定期重新拧紧螺丝及螺栓。

手入れの仕方:

全体を絞った布で拭き、特に汚れがひどいところは洗剤とスポンジを使って洗い落とし下さい。強力な洗剤や薬品は使用しないで下さい。ていないように時々締め直して下さい。

유지관리 지침:

젖은 헝겊으로 세척하고, 얼룩을 제거할 때는 스폰지에 솔벤트나 희석제를 사용하지 마세요.

产品说明书

产 品：儿童家具

产 品 编 号：参见标签或包装内的安装及使用说明。产品编号代表产品的类型、长度和颜色。例如：80-01101-1，为基本床，80-01101-190cm，80-01101-1-本色。80-01102-1，为基本床。80-01102-200cm，80-01102-2-白色。

技术特征和尺寸：见安装及使用说明。

主 料：北纬60度以上的北欧松木。

油 漆：水溶性UV漆，符合EN标准。

胶 水：水溶性粘合剂，符合EN标准。

金 属 配 件：镀层符合欧洲玩具安全标准EN71，第三部分。

芙莱莎集团出品的家具经过欧洲和美国最严格的安全测试，符合EN, CE, GS, CFR 标准，芙莱莎的产品经过国家家具质量监督检验中心的检测，符合儿童家具通用技术条件GB28007-2011——目前国内唯一的儿童家具国家强制标准和其他相关国家标准。同时我们符合欧洲标准EN717中针对甲醛释放量的要求。

安 装 及 配 送：见安装及使用说明。

日 常 维 护 保 养：见安装及使用说明。



安全保证 芙莱莎专为儿童制造，我们专注于每一个细节，以确保您可以安心布置儿童房，例如，芙莱莎儿童家具全无尖锐的边和角，所有边角都作磨圆处理；所有高度超过80厘米的床都要经过德国莱茵的高层床检测标准EN: 747



五年质保 芙莱莎的目标是提供始终如一的高品质和安全性，因此芙莱莎推出5年质保服务，但仅针对家具生产制造过程中造成的缺陷，不针对漆面的损伤。



五年附加保证 一旦您购买了芙莱莎，您就购买了一套灵活多变的家具体系，您可以根据您不断变化的需求来重新改装您的芙莱莎家具，这就是芙莱莎五年附加质保服务，即在您购买第一套芙莱莎床品的五年内，您可以根据您的需求添置新的部件，组装成满足您需求的新的床品。



高品质的木材 芙莱莎始终如一的坚持最高品质，例如，我们只选用北纬斯堪地纳维亚森林中最优质的松木制作儿童家具。



掉漆 芙莱莎儿童家具的表面都用水性UV漆涂刷好几遍，以确保家具的最佳呈现，同时，可以让家具更加耐磨耐损。芙莱莎所使用的水性UV漆达到EU标准。



自然色差异 芙莱莎家具由纯松木制成，由于实木具有活性，因此会存在天然的色差，所有芙莱莎纺织品也由100%天然材料制成，因此也会存在色差

芙莱莎儿童家具产自丹麦，依照斯堪的纳维亚风格所设计。芙莱莎实木家具均由欧洲生产，然后发往全球销售。

芙莱莎® 和 FLEXA® 是 Flexa4Dreams Holding A/S (芙莱莎) 集团的注册商标。

适用于3岁以上年龄
只允许成人安装，儿童勿近

生产商: FLEXA4Dreams Holding A/S, Denmark
地 址: Hornsyld Industrivej 4, 8783 Hornsyld, Denmark
电 话: +45 7668 8055 传真: +45 7668 8069
邮 箱: flexa@flexa.dk
网 址: www.flexa.dk

Product Declaration

Product: Children's furniture

Product No: Please refer to the label or the Assembly and User Instruction. The product code refers to the type, length and color of the product. As an example the item number 80-01101-1, a basic bed, 80-01101 - 190cm long, 80-01101-1-clear lacquered. 80-01102-2, a basic bed, 80-01102 - 200cm long, 80-01102-2 · white lacquered.

Technical character and size: Please refer to the Assembly and User Instruction.

Main material: Northern European Pinewood, harvested above the 60th latitude
Lacquer: Water soluble UV lacquer complying with the EN standard
Glue: Urea glue complying with the EN standard
Metal parts: Coating complying with the EN71 standard, part 3

Production date: Please refer to the label on the outer package.

Furniture products from FLEXA® are tested according to relevant European and American safety standards, e. g. EN, CE, GS, and CFR. Furthermore, FLEXA's products are test by the China National Quality Supervision Center for Furniture and complying with the GB28007-2011 children furniture standard in China and other relevant standards. Also, we comply with the EN717 concern the formaldehyde release.

Assembly and spare parts: Please refer to the Assembly and User Instruction.

Maintenance: Please refer to the Assembly and User Instruction.



Safety tested FLEXA furniture is made for children. We have carefully checked every single detail so you can safely set up your child's bedroom. For example, there are no sharp edges or corners on FLEXA furniture - they are all rounded. All beds with a sleeping height of more than 80 cm are safety tested according to the EU standard EN:747 by TÜV.



5-year guarantee FLEXA's aim is always to deliver the highest quality and safety. That is why we provide a 5-year guarantee against manufacturing defects on all our furniture. The guarantee does not cover damage to the lacquer surface caused by knocks or wear and tear.



5-year availability guarantee When you purchase FLEXA, you buy a flexible system that can be altered and extended as and when the need arises. The FLEXA availability guarantee means that you can buy new modules for your bed for at least five years after you purchased the first unit.



Quality materials FLEXA insists on the highest quality and sustainability as a standard when we make furniture. For example, we only use the highest quality pine from sustainable forests in Scandinavian. We are thereby ensuring that only the very best material is used for our furniture.



Lacquer FLEXA furniture is surface treated with lacquer several times to give our furniture an optimal and elegant finish. At the same time it makes our furniture robust and more resistant to signs of wear and tear. FLEXA is only using eco-friendly water-based lacquer and UV lacquer, which meets the EU standard for lacquer.



Colour differences Many FLEXA furniture is made of solid wood or part of it is in solid wood and natural differences in colour may appear between individual products. This is only natural since wood is a living product. All FLEXA textiles are 100% natural products. Natural differences in colour may occur.

Children's furniture from the Danish company, FLEXA, is designed by FLEXA according to Scandinavian design traditions. The wood furniture are manufactured by FLEXA in Europe and sold worldwide.

FLEXA® and the FLEXA® logo are trademarks of Flexa4Dreams Holding A/S.

For 3 years old or above.
Only for adult to assemble.

Manufacturer: FLEXA4Dreams Holding A/S, Denmark
Address: Hornsyld Industrivej 4, 8783 Hornsyld, Denmark
Tel: +45 7668 8055 Fax: +45 7668 8069
Email: flexa@flexa.dk
Website: www.flexa.dk